

LED AMENITY LIGHT. MOON STAR



MOON STAR								
Power	LED 30W	LED 40W	LED 50W	LED 60W	LED 70W	LED 80W	LED 120W	LED 150W
Lumen	3960 lm	4800 lm	6750 lm	7920 lm	10400 lm	12500 lm	15000 lm	18000 lm
Efficacy	130~150lm/W							
CCT	4000K (2700K~6500K optional)							
Weight	8.4kg (Type 1), 8.8kg (Type 2), 8.2kg (Type 3), 7.9kg (Type 4)							
Carton	630x630x150mm (Type 1) (1pc per carton-10kg/carton)				630x530x150mm (Type 2) (1pc per carton-10.3kg/carton)			
	630x530x150mm (Type 3) (1pc per carton-9.6kg/carton)				630x530x150mm (Type 4) (1pc per carton-9.3kg/carton)			

Protection : IP66
 Input Voltage : AC240V
 Impact Protection : IK08
 Color Rendering Index (CRI) : 70 (80 Optional)
 Material : Die-cast Aluminium Body with Pure Polyester
 Electrostatic Spray with 4mm Super White Toughened
 Glass, Silicon Rubber Seal Ring, Stainless Screws

Installation

**Cut-off connector (Power automatically switch off when opening)*



LED AMENITY LIGHT. MOON STAR



MOON STAR Type of Installation on Pole

TYPE 1

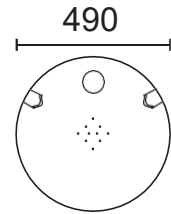
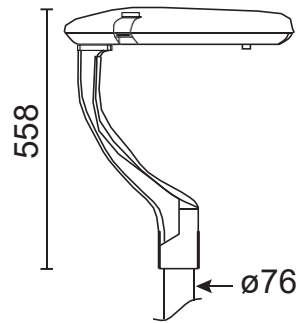

TYPE 2

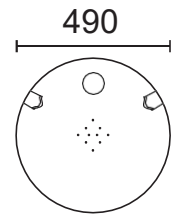
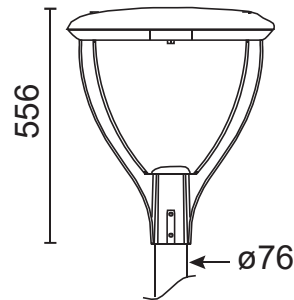

TYPE 3

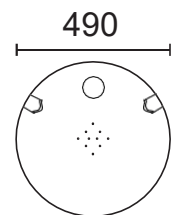
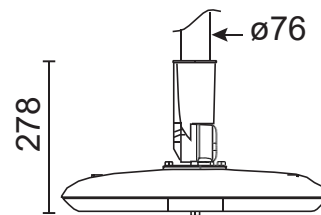

TYPE 4

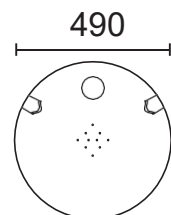
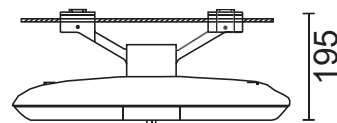

LED AMENITY LIGHT. BMLG



BMLG 1009	
Power	LED 40W~80W (Max)
Efficacy	110lm/W
Weight	7.2kg
Carton	610x610x410mm (1pc per carton-8.2kg/carton)

BMLG 1018	
Power	LED 30W~60W (Max)
Efficacy	110lm/W
Weight	4.5kg
Carton	550x550x280mm (1pc per carton-5.5kg/carton)

Protection : IP65
 Input Voltage : AC240V
 Material : Aluminium Body

Protection : IP65
 Input Voltage : AC240V
 Material : Die-Cast Aluminium Body
 with Power Coating and
 Anticorrosion Treatment

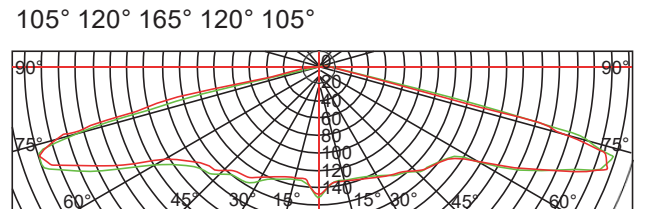
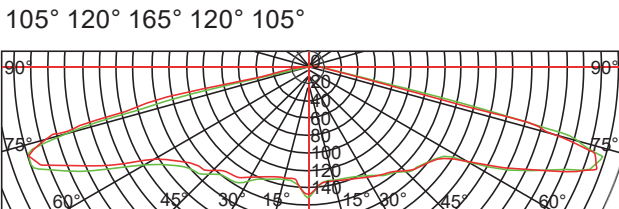
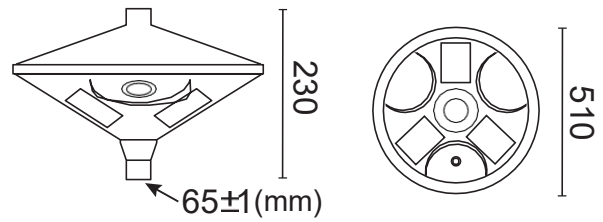
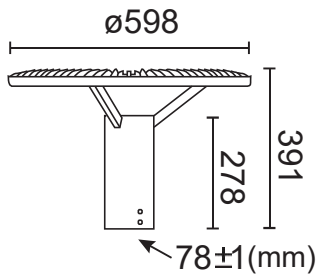

LED AMENITY LIGHT. BMLG



BMLG 1007	
Power	LED 30W~80W (Max)
Efficacy	110lm/W
Weight	7kg
Carton	410x410x850mm (1pc per carton-8kg/carton)

Protection : IP65
 Input Voltage : AC240V
 Material : Aluminium Body



BMLG 1008	
Power	LED 30W~80W (Max)
Efficacy	110lm/W
Weight	8.5kg
Carton	550x550x900mm (1pc per carton-10kg/carton)

Protection : IP65
 Input Voltage : AC240V
 Material : Aluminium Body

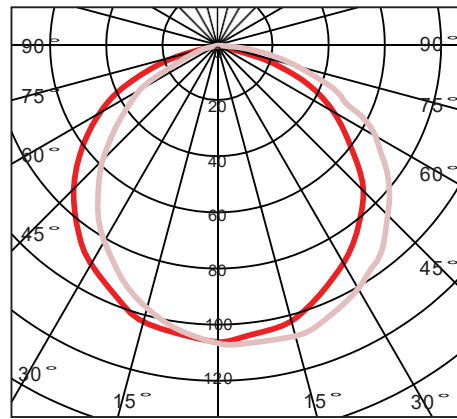
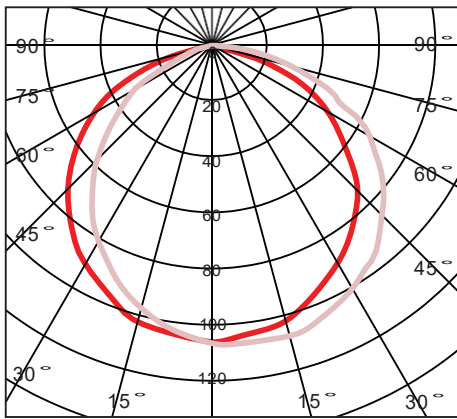

LED AMENITY LIGHT. BMLG/MAL Berry

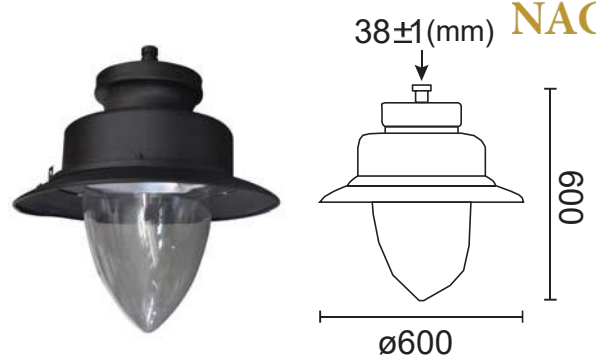
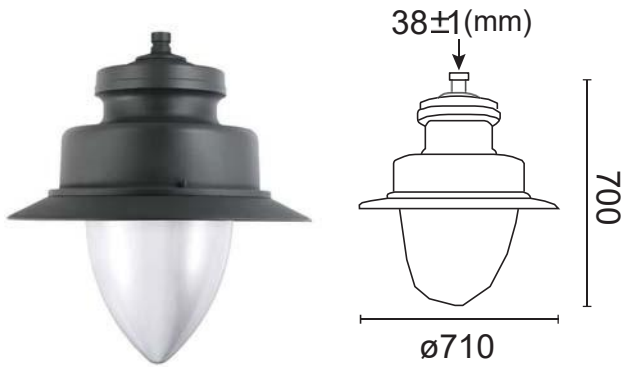

BMLG 1001A	
Power	LED 30W~150W (Max)
Efficacy	110lm/W
Weight	7.5kg
Carton	600x600x600mm (1pc per carton-8.5kg/carton)

BMLG 1001B	
Power	LED 30W~90W (Max)
Efficacy	110lm/W
Weight	6kg
Carton	520x520x520mm (1pc per carton-7kg/carton)

Protection : IP66
 Input Voltage : AC240V
 Material : Aluminium

Protection : IP66
 Input Voltage : AC240V
 Material : Aluminium Sheet Rotating Cover

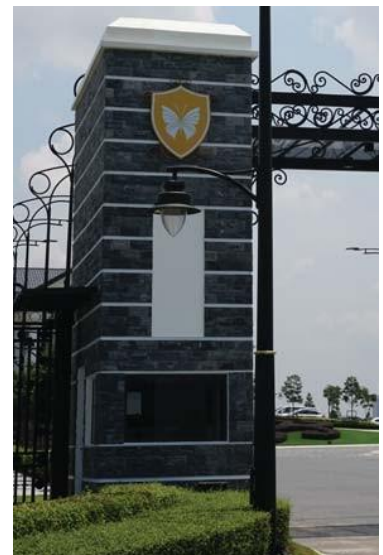
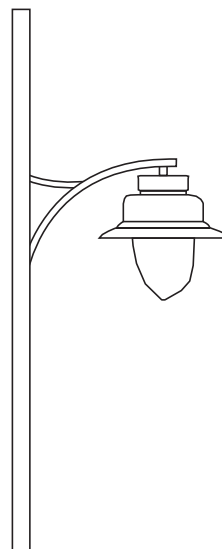
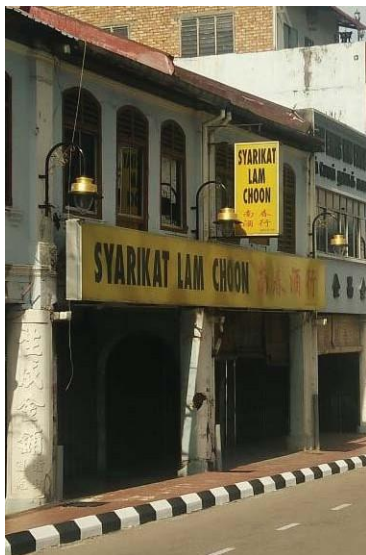
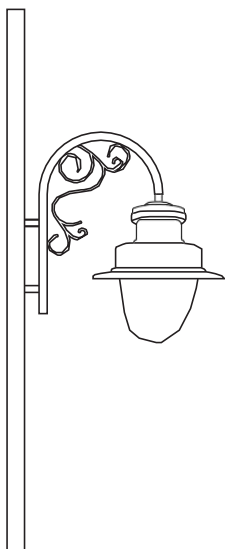
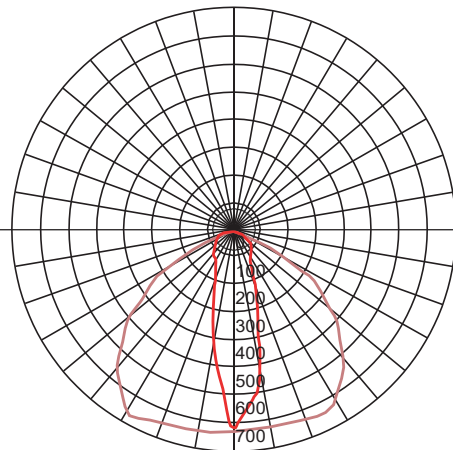
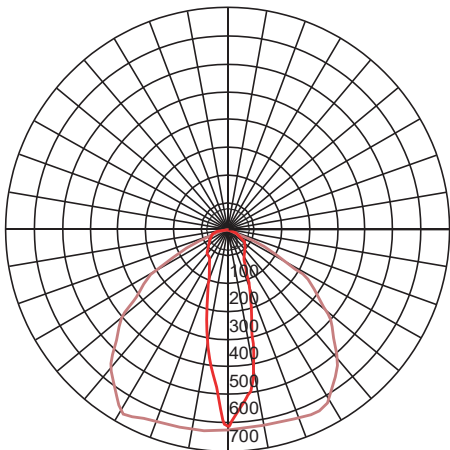

LED AMENITY LIGHT. BTLED

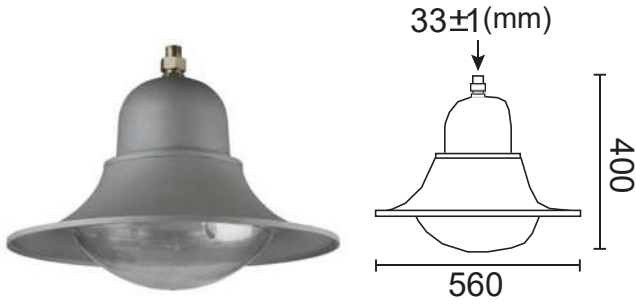

BTLED 607A	
Power	LED 20W~90W (Max)
Efficacy	110lm/W
Weight	5kg
Carton	480x480x480mm (1pc per carton-6.6kg/carton)

BTLED 607B	
Power	LED 20W~90W (Max)
Efficacy	110lm/W
Weight	5.4kg
Carton	480x480x480mm (1pc per carton-7kg/carton)

Protection : IP66
 Input Voltage : AC240V
 Material : Die-Cast Aluminium

Protection : IP66
 Input Voltage : AC240V
 Material : Die-Cast Aluminium

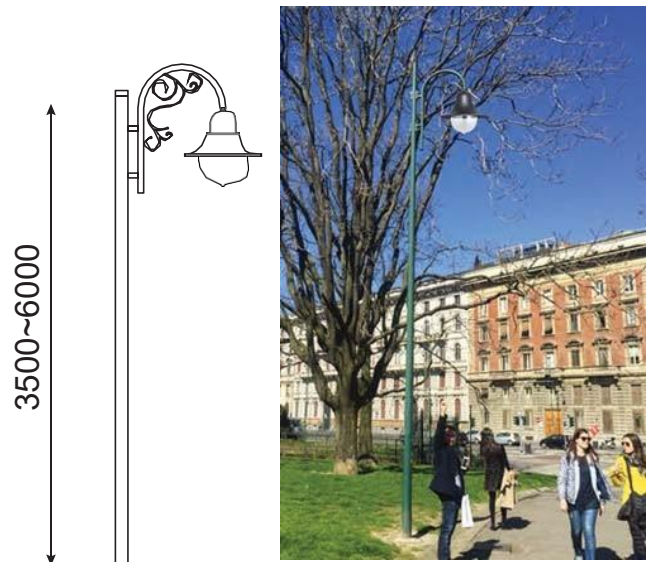
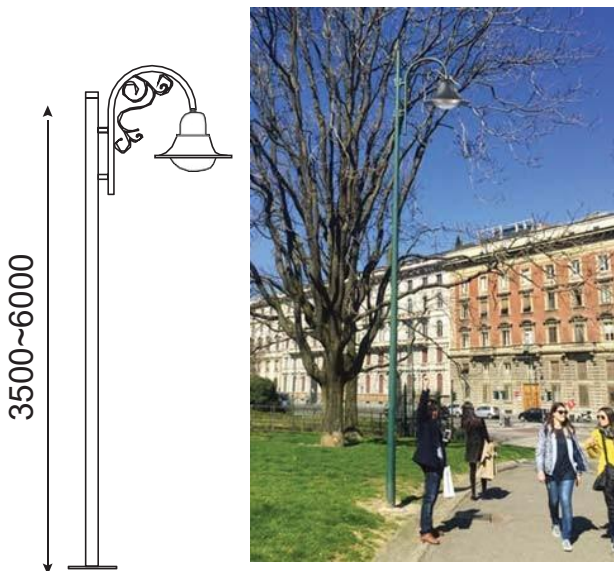
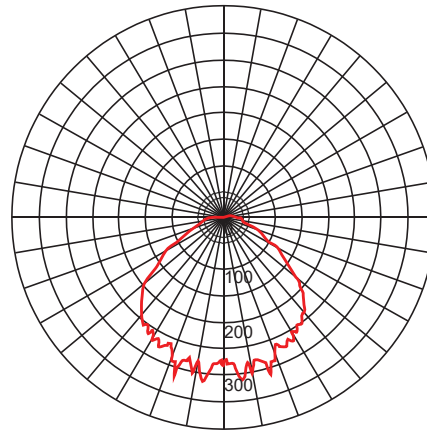
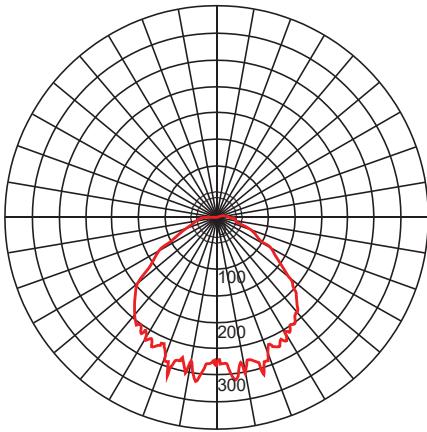

LED AMENITY LIGHT. Xelica 7242/MAL E93006

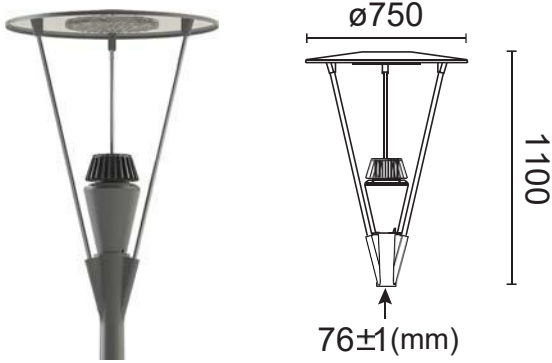

Xelica 7242	
Power	LED 55W (Max)
Efficacy	110lm/W
Weight	12.5kg
Carton	800x800x1200mm (1pc per carton-12.7kg/carton)

MAL E93006	
Power	LED 30W~60W (Max)
Efficacy	110lm/W
Weight	4.0kg
Carton	590x580x630mm (1pc per carton-6.0kg/carton)

Protection : IP65
 Input Voltage : AC240V
 Material : Die-Cast Aluminium Housing
 ADC12 Highly Polished PC Reflector, Symmetrical or Asymmetrical Reflector
 Driver : Built-in Constant Current

Protection : IP65
 Input Voltage : AC240V
 Material : Die-Cast Aluminium

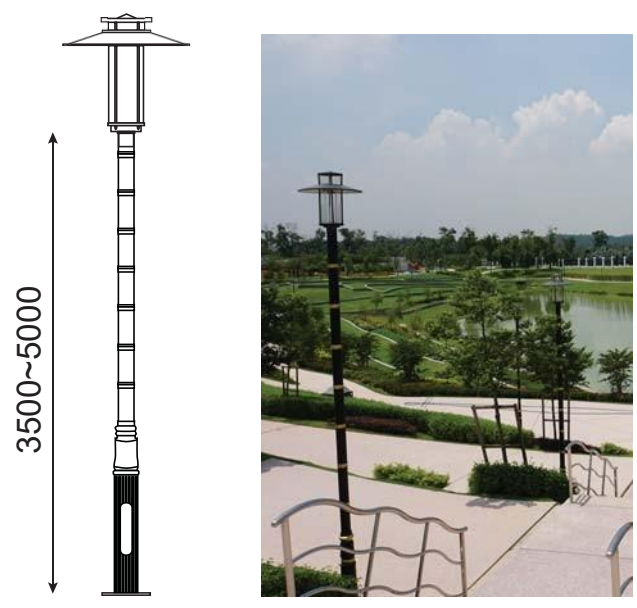
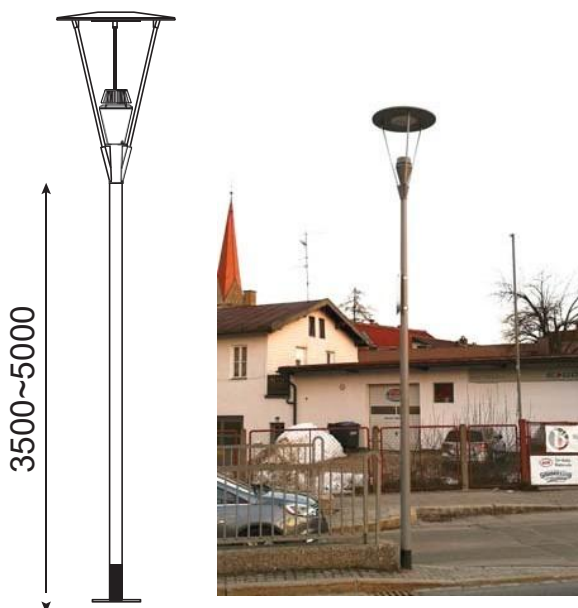
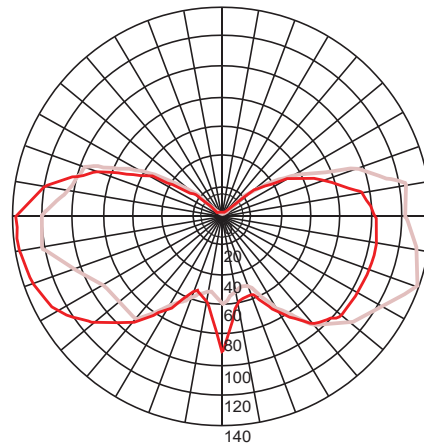
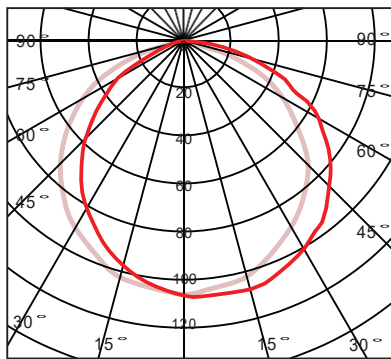

LED AMENITY LIGHT. LED 6132/LED CL998

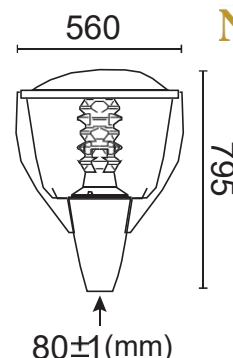
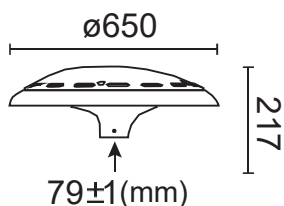

LED 6132	
Power	LED 30W~60W (Max)
Efficacy	110lm/W
Weight	9kg
Carton	710x285x725mm (1pc per carton-10.5kg/carton)

LED CL998	
Power	LED 30W~60W (Max)
Efficacy	110lm/W
Weight	4.0kg
Carton	590x580x630mm (1pc per carton-6.0kg/carton)

Protection : IP65
 Input Voltage : AC240V
 Material : Die-Cast Aluminium Housing,
 Aluminium Sheet Rotating
 Cover, PC Diffusion
 Technology, Sealed Lamp
 Housing

Protection : IP65
 Input Voltage : AC240V
 Material : Pressure Die-Cast Aluminium
 Reflector: : Anodized and Sealed Single,
 Piece High Purity Aluminium
 Plate
 Lens: : High transparent PMMA

Type 1

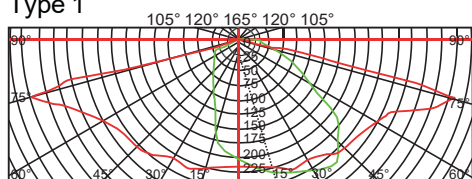

Type 2

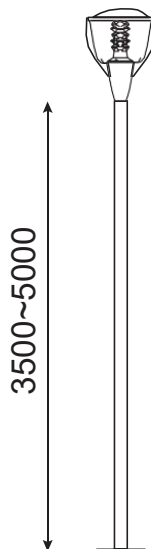
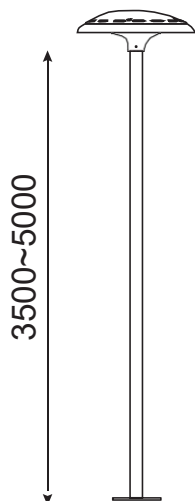
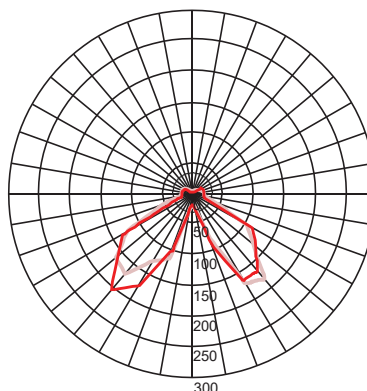
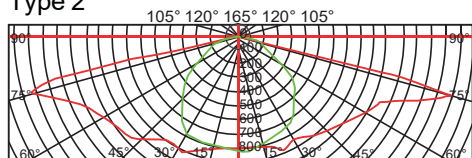

LED AMENITY LIGHT. Auris/MAL Ilusi

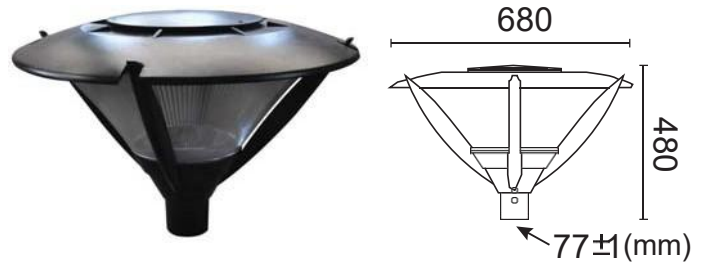
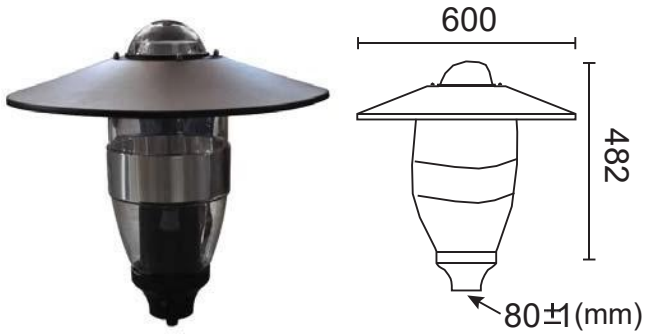

Auris	
Power	LED 30W~60W (Max)
Efficacy	110lm/W
Weight	7.0kg
Carton	450x450x570mm (1pc per carton-8.2kg/carton)

MAL Ilusi	
Power	LED 30W~60W (Max)
Efficacy	110lm/W
Weight	9.6kg
Carton	690x700x500mm (1pc per carton-12kg/carton)

Protection : IP65 - Optical Block
 IP54 - Gear Compartment
 Input Voltage : AC240V
 Material : Aluminium Sheet Rotating Cover

Protection : IP65
 Input Voltage : AC240V
 Material : Die-Cast Aluminium

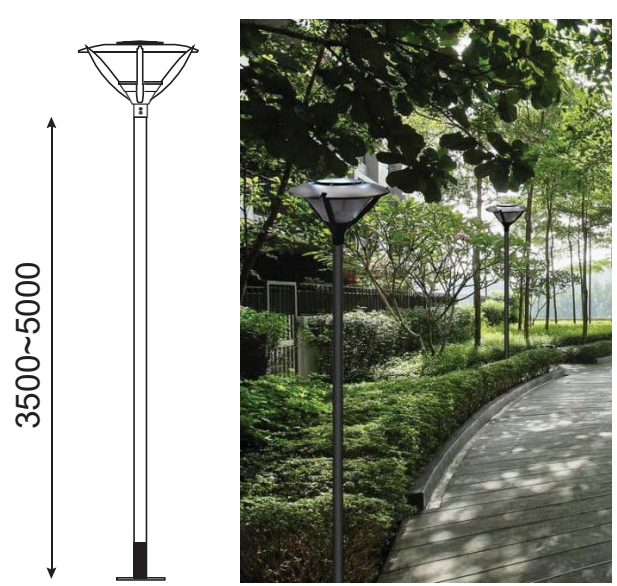
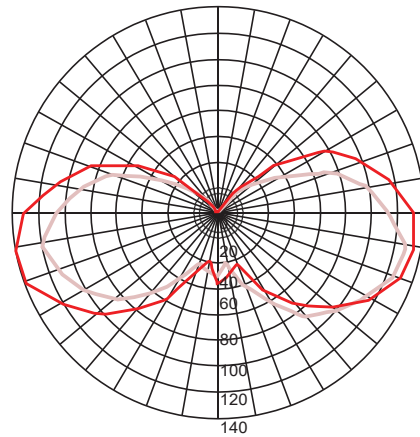
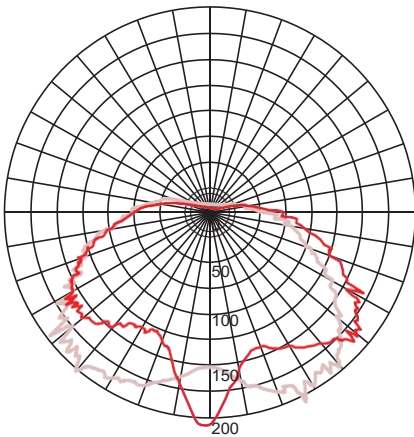

LED AMENITY LIGHT. LED 6102/LED 6135

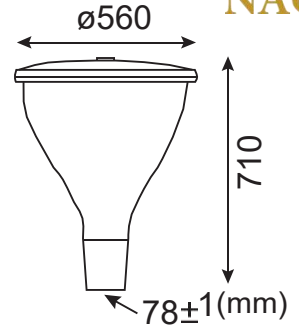
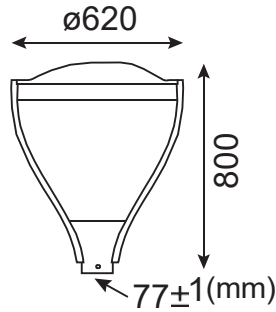

LED 6102	
Power	LED 35W,45W,55W,60W,70W
Efficacy	110lm/W
Weight	8kg
Carton	610x610x830mm (1pc per carton-13.5kg/carton)

LED 6135	
Power	LED 35W,45W,55W,60W,70W
Efficacy	110lm/W
Weight	9.2kg
Carton	605x605x750mm (1pc per carton-11.5kg/carton)

Protection : IP65
 Input Voltage : AC240V
 Material : Die-Cast Aluminium housing,
 Aluminium Sheet Rotating
 Cover, Double Photometric
 Diffuser Technology, Super
 White Toughened Glass,
 Sealed Lamp Housing

Protection : IP65
 Input Voltage : AC240V
 Material : Die-Cast Aluminium housing,
 Aluminium Sheet Rotating
 Cover, Double Photometric
 Diffuser Technology, UV-Stop
 PC Lamp Cover, Sealed
 Lamp Housing

Type 1

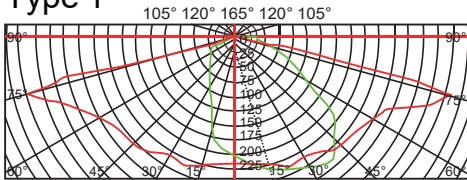

Type 1

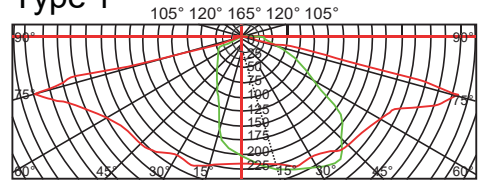

Type 2

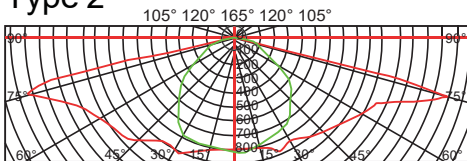

Type 2

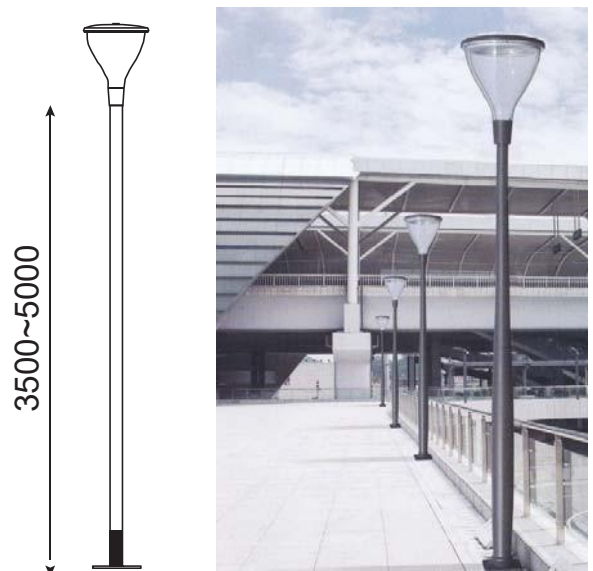
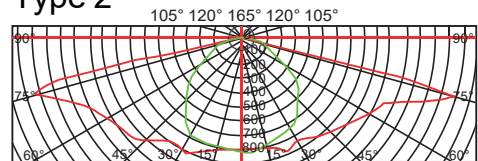

LED AMENITY LIGHT. LED CL99/VISO

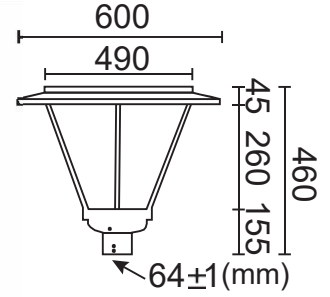
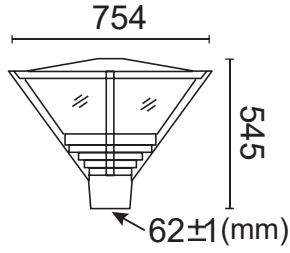

LED CL99	
Power	LED 30W~60W (Max)
Efficacy	110lm/W
Weight	10.1kg
Carton	580x580x550mm (1pc per carton-10.3kg/carton)

VISO	
Power	LED 30W~60W (Max)
Efficacy	110lm/W
Weight	7.2kg
Carton	600x600x510mm (1pc per carton-8.2kg/carton)

Protection : IP65
 Input Voltage : AC240V
 Material : Pressure Die-Cast Aluminium
 Reflector : Anodized and Sealed Single Piece High Purity Aluminium Plate
 Lens : High Transparent PMMA

Protection : IP65 - Optical Block
 IP54 - Gear Compartment
 Input Voltage : AC240V
 Material : Die Cast Aluminium with Aluminium Reflector. Aluminium Plate Spinning.

